



# IJEAST

INTERNATIONAL JOURNAL  
OF ENGINEERING APPLIED SCIENCE  
AND TECHNOLOGY



**VOLUME : 5    ISSUE : 3    Print / Issue Publication Date: 15-Sep-2020**



**ISSN : 2455-2143**



**DOI : 10.33564/IJEAST.2020.v05i03.095**

Indexed In



[WWW.IJEAST.COM](http://WWW.IJEAST.COM)

[editor@ijeast.com](mailto:editor@ijeast.com)

# IOT SOLUTION FOR AUTOMATIC WATERING OF INDOOR PLANTS

Ramya B V  
Department of ISE  
BMSCE, Bangalore,  
Karnataka, India

Lakshmi S R  
Department of ISE  
BMSCE, Bangalore,  
Karnataka, India

Rashmi B T  
Department of ISE  
BMSCE, Bangalore,  
Karnataka, India

**Abstract:** Water is very essential for every living things like animals, plants, human beings etc. Water is important for plants as it helps root to absorb essential nutrients from soil. Sometimes when we are not near to our plants we cannot water them when they need the water. This paper provides solution by implementing automatic plant watering system using IOT. This system includes sensors, microcontroller and some other electronic components. Soil moisture sensor senses the soil moisture level and if the level is less than the threshold value notification is sent to user mobile. This will help us to take care of our plants.

**Keywords**— IOT, plants, water.

## I. INTRODUCTION

Nowadays, advanced technologies are mainly focusing on making life of human beings simpler. This can be done through developing automated systems which reduces the effort of human beings. Automatic plant watering system is one such system which uses soil moisture sensor for sensing the soil moisture level, NodeMCU (Node Micro Controller Unit) as processing unit for checking whether moisture level is less than threshold value, Servo motor to rotate the tap for water flow. When the soil moisture level is less than fixed threshold value it means that plant needs water this notification is sent to user mobile through Blynk software application.

Can we water the plants in our garden even when we are on vacation for long period without bothering about neighbors? Irregular watering leads to minerals loss for plant, which may affect growth of plants. So can we know by somehow that when our plants need the water? Is it possible to manage our plants from remote location? These are few questions which can be answered by automatic watering system.

Today, innovations focus mainly on controlling and monitoring the systems wirelessly over internet, where internet acts as medium for communication. A system is considered as a smart system if it consists of sensors, microcontrollers, actuators and software applications. In automated plant watering system the soil moisture sensor is used to collect the data, Microcontroller is used as processing unit, Blynk software application is used to monitor the plant. The main aim of this paper is to provide automatic watering indoor plants.

IoT has a unique addressable things and their virtual illustration on an internet like structure. Such things can add to data about them, or can send real-time sensor information about their state or other properties combined with the things. The unique address things are connected to the web, and the data can send using the protocol that communicates computers to the internet. Since the things can sense the environment and communicate and may generally enable automatic reply to challenging scheme without human interference. The more numbers of objects meanwhile produce information from the environment in an automatic way and enable common and ubiquitous computing.

## II. SYSTEM ARCHITECTURE

The implemented system consists of NodeMCU as main processing unit, sensor and other devices are connected to it. The sensor is operated by microcontroller to retrieve the data from them and it processes the retrieved data.

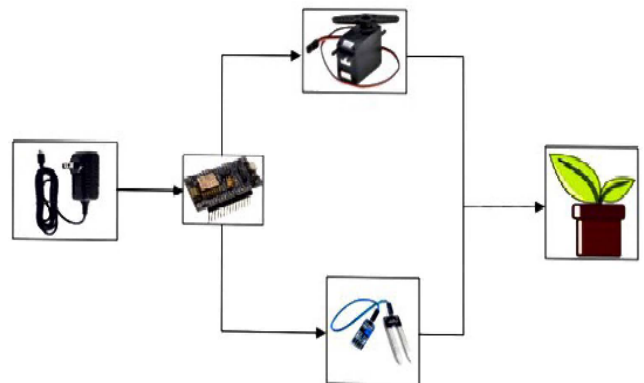

Fig 1.1: System setup

**Servo Motor:** A servo motor is an electrical device which can push or rotate an object with great precision. Rotates an object at some specific angle or distance.

**NodeMCU:** NodeMCU is an open source IoT platform. It includes firmware which runs on the ESP8266 Wi-Fi SoC from Espressif Systems, and hardware which is based on the ESP-12 module.

**Soil Moisture sensor:** The Soil Moisture Sensor uses capacitance to measure the water content of soil (by measuring

the dielectric permittivity of the soil, which is a function of the water content).

**Breadboard:** A breadboard is used to build and test circuits quickly before finalizing any circuit design. The breadboard has many holes into which circuit components like ICs and resistors can be inserted.

### III. FLOWCHART

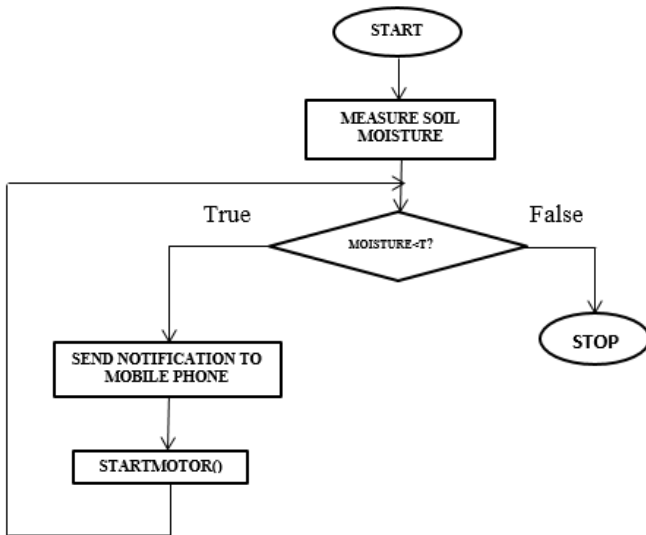

**Fig 1.2:** flowchart

### Data Collection

Soil moisture sensor which is placed in the pot would sense the moisture level of the soil in the pot. The value that is read by soil moisture sensor would be sent to the NodeMCU unit.

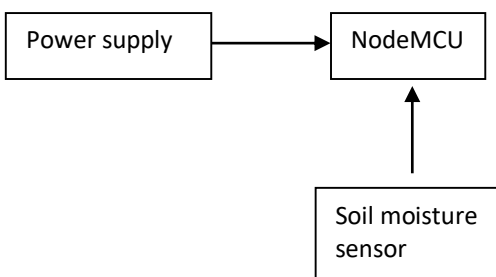

**Fig 1.3:** data input

### Data Transmission

After receiving data from soil moisture sensor NodeMCU would compare the value with normal value. If the moisture level is less than the normal value i.e. 1023, this means that soil is dried we need to pour water to that plant, then NodeMCU would sent notification to the owner.

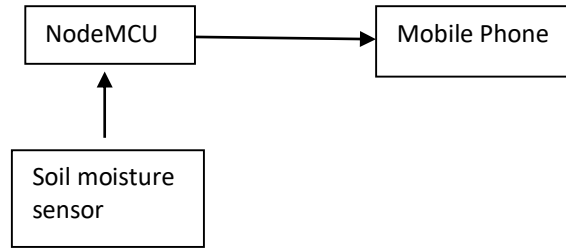

**Fig 1.4:** data transmission

### Notification system

This would get input from NodeMCU and then sends a notification to the owner indicating that plant needs water. This notification is received through an application i.e., Blynk. Notification POPUP will display on the screen of mobile Phone. This way it helps to pour water for the plant from any place. The owner can pour as much as water the plant needs by making use of ON and OFF Buttons provided in the application.

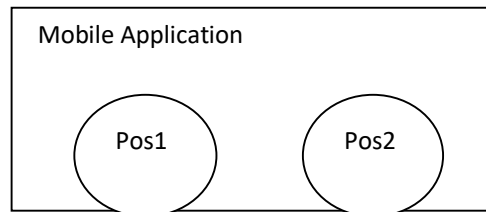

**Fig1.5:** notification system

### IV. RESULTS

Step 1: Set up in the mobile application Blynk

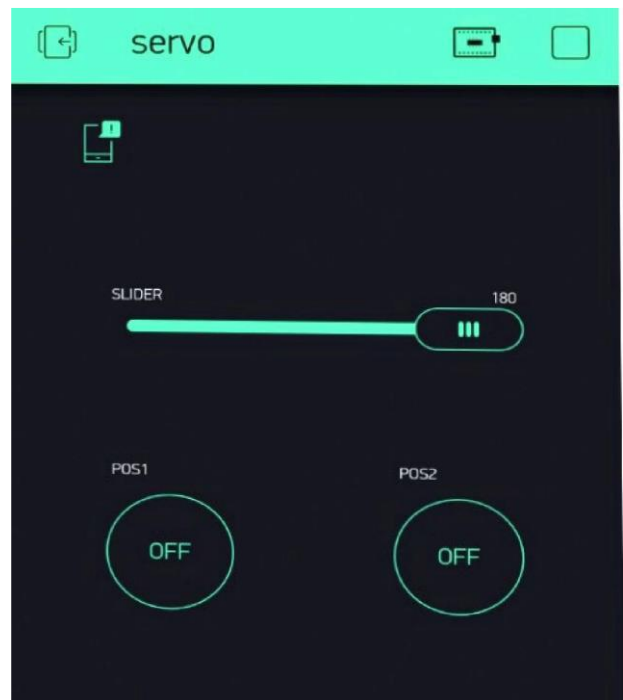

**Fig 1.6:** Blynk application setup

Step 2: Sensor notification

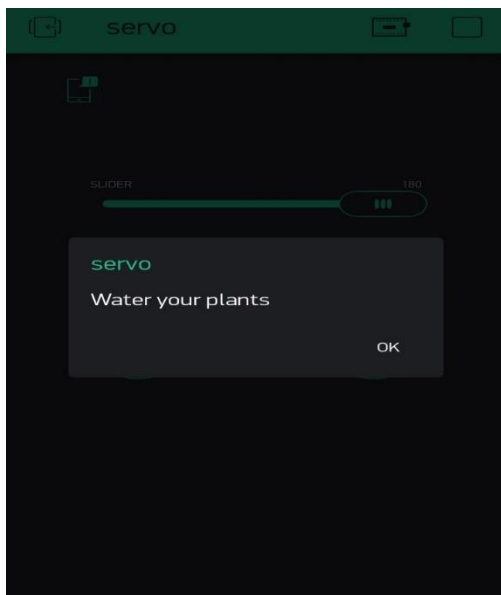

**Fig 1.7:** notification

Step 3: Watering the plants



**Fig1.8:** system setup

V. CONCLUSION

Proposed system is cost effective for watering indoor plants. Soil moisture sensor is used to collect the data from the soil in the pot and these values are sent to NodeMCU, upon receiving the data from sensor it compares the value with the threshold value. If the value is normal then it's clear that soil is wet, if it is less than threshold value it sends notification to owner mobile. This notification is sent to application called Blynk, after seeing this notification the owner can pour water to plant by starting motor. This operation can be done from anywhere in global.

1. Tasneem Khan Shifa, (2018), "Moisture Sensing Automatic Plant Watering System Using Arduino Uno", AJER. pp: 326-330.
2. S. V. Devika, Sk. Khamuruddeen, Sk. Khamurunnisa, Jayanth Thota, Khalesha Shaik, (October-2014), "Arduino Based Automatic Plant Watering System", IJARCSSE, pp:449-456.
3. Abhishek Kumar, Magesh.S, (2017), "AUTOMATED IRRIGATION SYSTEM BASED ON SOIL MOISTURE USING ARDUINO", IJPAM, pp: 319-323.
4. D.V.Debila Mol, D.V.Delsya Mol, S.Guna Sheela, G.T.Jenisha, (March 2019), "IOT BASED PLANT WATERING AND MONITERING SYSTEM FOR SMART GARDENING", IJRTER, DOI: 10.23883.
5. Ditya Padyal, Saylee Shitole, Sagar Tilekar, Pratik Raut "Automated Water Irrigation System Using Arduino Uno And Raspberry pi with Android Interface" ISSN:2395-0072.
6. Spoorthi P A, Darshan Yadav P A, Ripal Patel, (Nov-Dec 2019),"IOT Based Automatic Irrigation System using Soil Moisture Sensors", IJCTA, pp: 160-164.
7. Naik, P., Kumbi, A., Hiregoudar, C. V., Pavitra, H., & Sushma, B. (2017). "Arduino Based Automatic Irrigation System Using IoT", IJSRCSEIT, pp: 881-886.
8. Iaghusooriya, E. M., Anitha, K., & Anjana, C. R. (2017). "Trust Mechanism Protocol for Automatic Smart Irrigation ampers and sign nbsp; System Using WSN", IJASRE.
9. Ghosh, S., Sayyed, S., Wani, K., Mhatre, M., & Hingoliwala, H. A. (2016, December). "Smart irrigation: A smart drip irrigation system using cloud, android and data mining". ICAECCT, pp. 236-239. IEEE.
10. Banumathi, P., Saravanan, D., Sathiyapriya, M., & Saranya, V. (2017). "An Android Based Automatic Irrigation System Using Bayesian Network with SMS and Voice Alert", IJSRCSEIT, pp: 573-578.
11. Umesh Maru, Rajesh Jain, Gajendra Sujediya "Automated Plants Watering System Using Arduino UNO Board" ISSS: 2320-2882.
12. Y. Kim and R. G. Evans,(May 2019), "Software design for wireless sensor-based site-specific irrigation", pp:159-165
13. Archana P, Priya R. "Design And Implementation Of Automatic Plant Watering System", ISSN NO: 2309-4893.
14. Chikankar, P. B., Mehetre, D., & Das, S. (2015, January). "An automatic irrigation system using ZigBee in wireless sensor network". ICPC, pp. 1-5. IEEE.

# IJEAST

INTERNATIONAL JOURNAL  
OF ENGINEERING APPLIED SCIENCE  
AND TECHNOLOGY

## ABOUT IJEAST

International Journal of Engineering Applied Science and Technology (IJEAST) is a peer-reviewed, open access journal that publishes high-quality research papers in the field of Engineering, Applied Science and Technology.

IJEAST aims to provide a platform for researchers, academicians, and professionals to share their innovative ideas, research findings, and practical experiences with the global scientific community.

## FOCUS AREAS

- Engineering
- Applied Science
- Technology
- Innovation & Development
- Interdisciplinary Studies



### PEER REVIEWED

All submissions are rigorously peer reviewed to ensure quality.



### OPEN ACCESS

Free and unrestricted access to research for all.



### GLOBAL REACH

Connecting researchers and professionals worldwide.



### TIMELY PUBLICATION

We ensure a swift and efficient publication process.



For more information, visit our website  
[www.ijeast.com](http://www.ijeast.com)



INTERNATIONAL JOURNAL  
OF ENGINEERING APPLIED SCIENCE  
AND TECHNOLOGY

✉ [editor@ijeast.com](mailto:editor@ijeast.com)

🌐 [www.ijeast.com](http://www.ijeast.com)

📍 India



2455-2143