



IJEAST

INTERNATIONAL JOURNAL
OF ENGINEERING APPLIED SCIENCE
AND TECHNOLOGY



VOLUME : 6 ISSUE : 7 Print / Issue Publication Date: 25-Feb-2022



ISSN : 2455-2143



DOI : 10.33564/IJEAST.2021.v06i07.045

Indexed In



WWW.IJEAST.COM

editor@ijeast.com



OPTIMIZATION OF CAR DOOR HANDLE USING HONEYCOMB STRUCTURE AND 3D PRINTING TECHNOLOGY

Mr. Prathmesh Mandlik,
Department of Mechanical
MGM's College of Engineering, Nanded Maharashtra,
India

Prof. J.K.Sawale
Department of Mechanical
MGM's College of Engineering, Nanded Maharashtra,
India

Abstract— Car doors are the crucial hardware used by human beings in day to day life. Doors of the vehicles are used for security purposes. To use the door in the efficient way, we need handle and it is the most important part in door. Door handles are used for opening and closing of a door with less effort. Various types of door handles such as lever handle, doorknob are the different kind of handles we came across in our daily life. There are various designs of door handles are already available so that we are not aware of door handles selection criteria. The aim of this work is to study the different materials and internal design of car door handle. For that purpose we used Finite Element Analysis (FEA) software to know which material and shape have more strength and optimize design. In this project we used two different structure one is honeycomb structure and other is auxetic structure for inside section of car door handle. Optimized car door interior handle will be manufacture using 3D printing technology. The behaviour of this structures under three point bending were investigated by using UTM

Keywords— 3D Printing, FDM, Honeycomb structure.

I. INTRODUCTION

The car door handles are the hardware used for opening and closing of doors. Doors are used for security purposes of our goods. There are many kinds of doors like passage, closet, dummy doors etc. similarly there are various kinds of door handles used for variety of doors and their functionality. Door handles are installed on doors to simply open and close the door with minimum effort. As the name suggest, handle is used to open and close car doors. The handle is found on both the Inside and outside of automobile doors, so they are used differently on each panel. The one on the outside is dragged to open the vehicle door, while the inside handle is used to release the door latch before you can push the door to let yourself out. In this project interior door handle is taken into inspection.

Car interior door handles are designed ergonomically for the comfort of the driver and occupants. So, the interior car door handles are designed aesthetically and ergonomically.

Ergonomic Considerations are defined as the relationship between man and machine and the application of anatomical, physical and cognitive principles to solve the problems arising from man-machine relationship.

Door handles can be made from long lasting plastic and metals like aluminium alloy, zinc alloy, and magnesium alloy.

II. PROPOSED ALGORITHM

A. Problem Statement

The interior door handles of vehicle is typically made of distinct materials. Unlike the materials used on the outer side of the vehicle door, the material on the interior side serves a greater purpose other than just aesthetic purpose. The aim of this work is to study different material and internal design of car door interior handle. For that purpose we used Finite Element Analysis (FEA) software for understanding which material and shape have more strength and optimize design. In this project we used two different structure one is honeycomb structure and other is auxetic structure for inside section of car door handle. Optimized car door interior handle will be manufacture using 3D printing technology. The behaviour of this structures under three point bending were investigated by using universal testing machine (UTM).

B. Objectives

Modeling car door interior handle with two different internal structure in CATIA V5 software.

Analyzing for stresses and deformation in car door interior handle of vehicle using ANSYS 19 software.

To manufacturing of car door interior handle of vehicle using 3D printing technology.

The behaviors of car door interior handle under three-point bending were investigated by using UTM. Experimental testing and correlating results

C] Chronology



Fig . chronology

D. DESIGN

Modeling car door interior handle with two different internal structure in CATIA V5 software. Design considerations The human factor aspect of designing automobiles is considered for the car door handle dimension and location. It is a method to provide comfort and effective working space for the driver and the occupant.

E] Analysis of handle using polyethylene Material Meshing

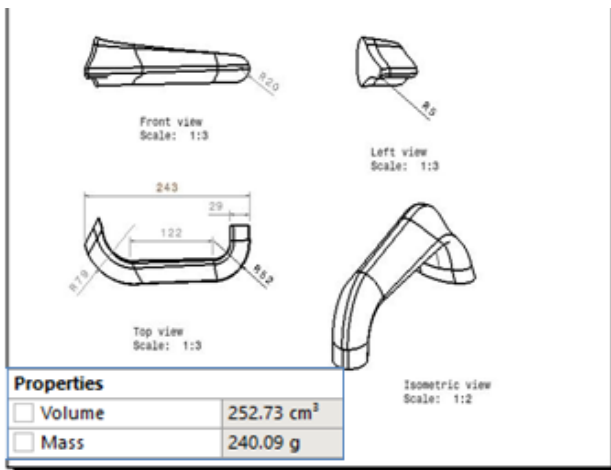

Fig. Meshing

Boundary Condition



Fig Boundary Condition

The maximum weight apply on the door handle is the weight of human. So we consider the weight of human is 100kg with the factor of safety.
 So the maximum force apply on car door is $100 \times 9.81 = 1000N$
 So we apply the 1000N load on car door and fixed both end of the car door.

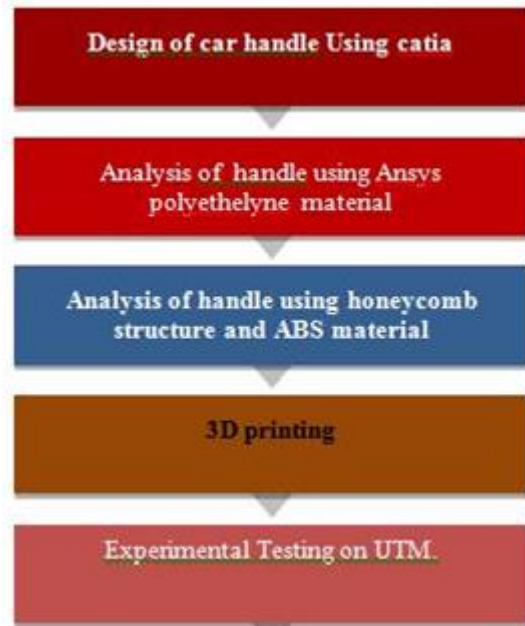

Fig. Design of the handle

Results

Total Deformation

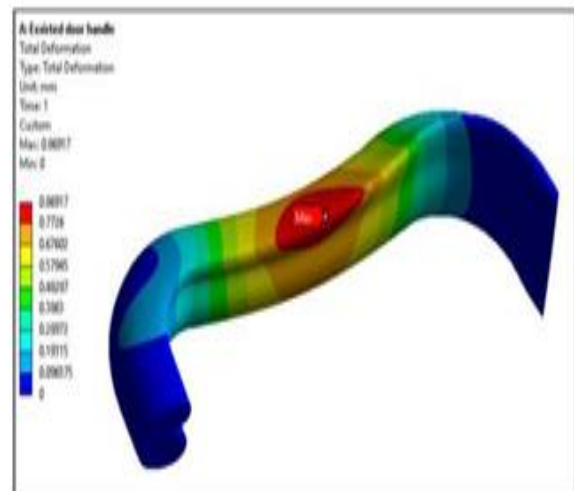

Fig Total Deformation of the handle

Equivalent Stress

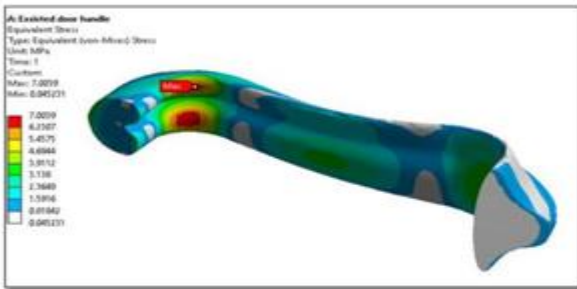

Fig Equivalent stress on handle

F]. Analysis of car door handle with ABS material and Honeycomb Structure:

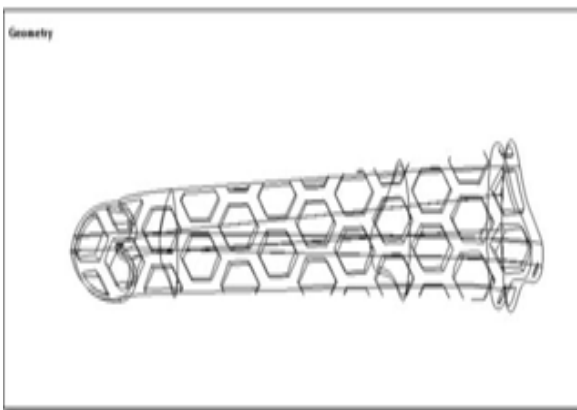

Fig. honeycomb structure

Meshing

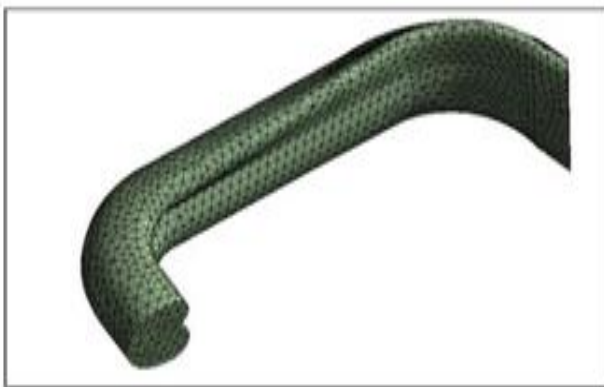

Fig Meshing

Boundary Conditions

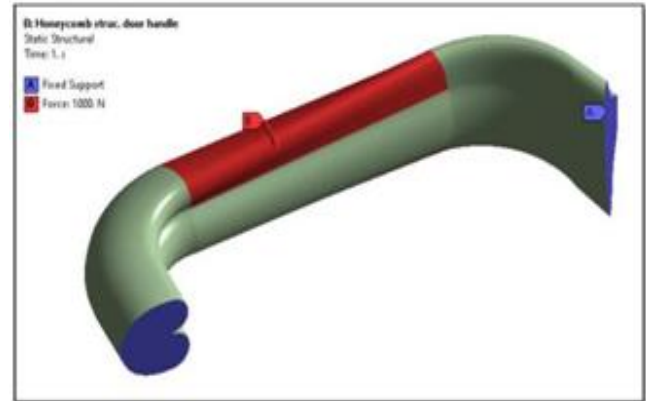

Fig. Boundary Condition

Deformation Plot

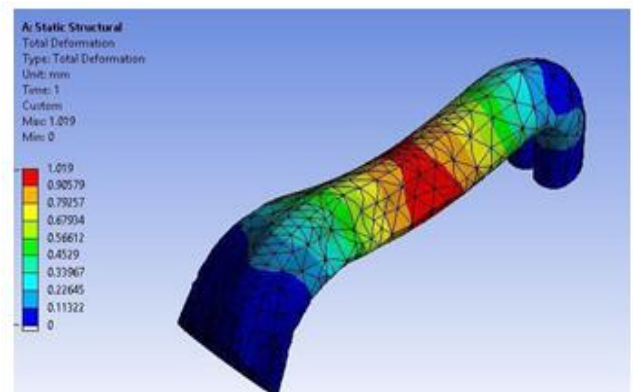

Fig Deformation Plot

Equivalent Stress

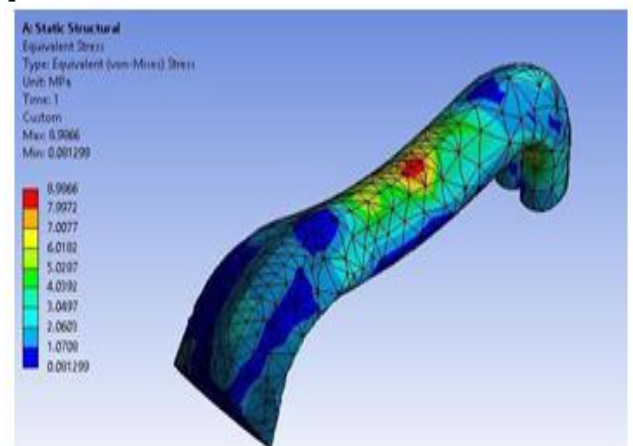

Fig. Equivalent Stress

In this project we develop existing car door handle is selected to perform FEA analysis to determine maximum deformation and respective equivalent stress.

Static structural analysis of car door handle is performed to determine deformation and equivalent stress. It is observed that around maximum deformation is 0.86 mm and equivalent stress is 7.0 MPa.

We optimized existing model using honeycomb structure and ABS material to reduce the weight. Hence, we develop 3D cad model of optimized door handle

G] 3D Printing

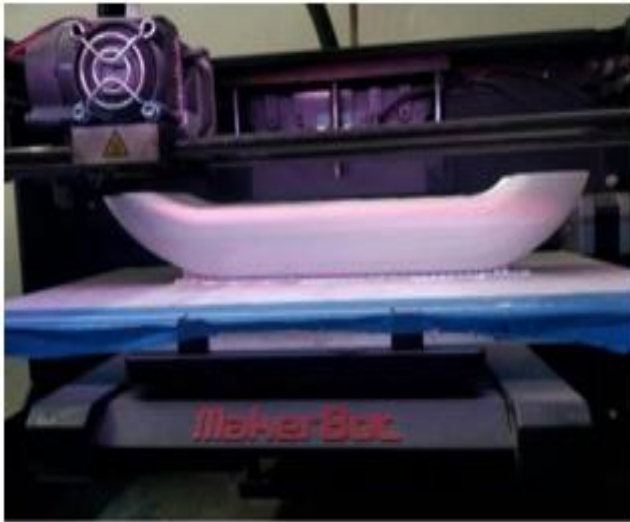

Fig. 3D printing of the handle

Technical considerations for 3D Printing –

Material – ABS/WHITE

Resin Thickness is 0.2 mm

Speed 60mm/sec

Time 4 hour 25 Minute

3D printer Used

Made – Maker Bot FDM

Travel : 150 mm/sec

Infillet 20%



III. EXPERIMENT AND RESULT

After the 3D printing of the handle. performed Experimental Testing with the help of UTM. Using Three point bending test

Meshing

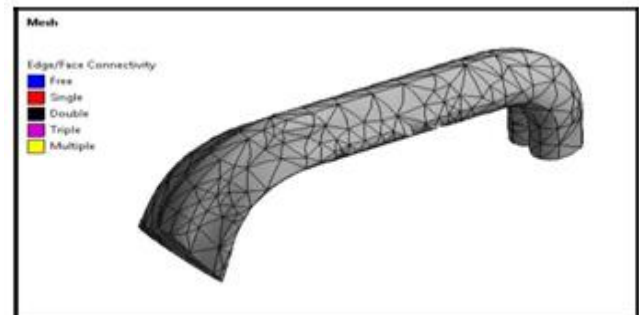

Fig. meshing

Boundary Conditions

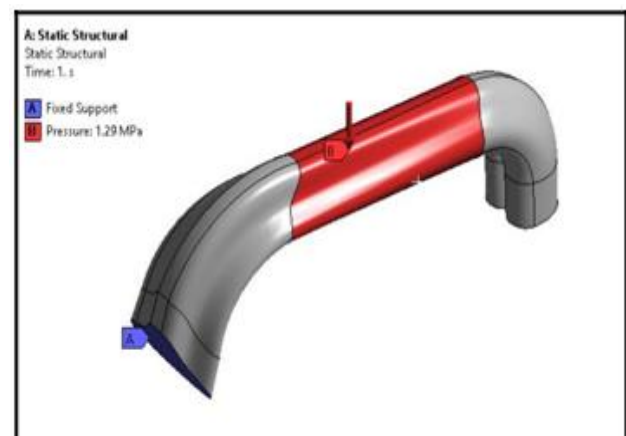

Fig. 3D Printed Handle

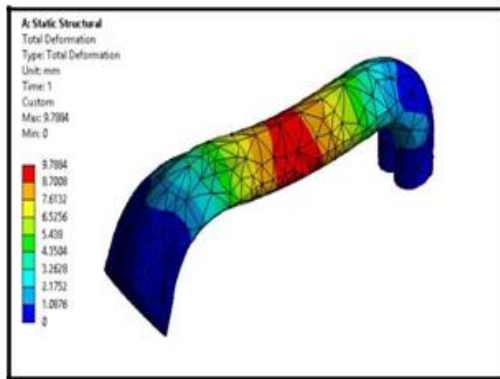

Fig Boundary condition

As we have non-uniform surface for the application of force we have applied gradual pressure on the interior car door handle and find out the results. We have applied 1.29 Mpa pressure.

Final Results

Deformation plot:



Analysis of the car door handle with polyethylene Material	Total Deformation = 0.8 mm Equivalent Stress = 7 mpa
Analysis of the car door handle with honeycomb structure and ABS Material	Total Deformation = 1 mm Equivalent Stress = 8.9 mpa
Experimental Analysis of Handle on UTM	Total Deformation = 9.8 mm. after deformation of 9.8 mm, it regains it's original shape.

Fig Deformation

Max. Deformation of the car door handle is 9.78mm
 As we have simply supported the car door handle on two ends. The gradual pressure is applied at the center portion.
 After experimental analysis of car door handle the deformation is noted as 9.8mm.
 After applying pressure on door handle, after deformation of 9.8 mm, it regains it's original shape.

Three Point Bending Test

We develop model of car door handle using 3D printing technique and use honeycomb structure inside the door handle to reduce the weight of the model compare to exist model.
 The weight of existing car door handle is 240.09g and the weight of optimized door handle is 200.94 g. So, the weight optimization in this project is 16.30 %.
 After experimental analysis of car door handle the deformation is noted as 9.8mm.
 After applying pressure on door handle, after deformation of 9.8 mm, it regains it's original shape.

IV. CONCLUSION

As the aim of this project is to reduce the weight and find strength of the car door handle. By using 3D printing technique, materials use for 3D printing is ABS. Car door handle is analyzed ANSYS software which utilizes finite element method technologies.
 In this project we develop existing car door handle is selected to perform FEA analysis to determine maximum deformation and respective equivalent stress.
 Static structural analysis of car door handle is performed to determine deformation and equivalent stress. It is observed that around maximum deformation is 0.86 mm and equivalent stress is 7.0 MPa.
 We optimized existing model using honeycomb structure and ABS material to reduce the weight. Hence, we develop 3D cad model of optimized door handle.
 Static structural analysis of 3d printing car door handle using ABS material is performed to determine deformation and equivalent stress. It is observed that around maximum deformation is 1 mm and equivalent stress 9.52 MPa.
 We develop model of car door handle using 3D printing technique and use honeycomb structure inside the door handle to reduce the weight of the model compare to exist model.



The weight of existing car door handle is 240.09g and the weight of optimized door handle is 200.94 g. So, the weight optimization in this project is 16.30 %.

After experimental analysis of car door handle the deformation is noted as 9.8mm.

After applying pressure on door handle, after deformation of 9.8 mm, it regains it's original shape.

V. REFERENCE

- [1]. "experimental analysis of dryer door handle to predict fatigue life compare with fea results" by sachinkhade, g. d. korwar. 2017 ijesc, volume 7 issue no.8.
- [2]. "finite element analysis and topology optimization design for automobile door-handle" by enguang zhang and xin zhang 2018 iop conf. ser.: mater. sci. eng. 392 062072.
- [3]. investigation of ergonomics design for the vehicle door handle for proton (blm) and perodua (viva) ka shamsuddin, ni mokhtar, mmamm aris, ta abdul razak. ijesrt september, 2015.
- [4]. optimizations of outer door handle in automobiles using composite material. girish naresh raut, prof v. p. mali. volume:04 issue: 05 | may -2017.
- [5]. "design of a vehicle door structure based on finite element method" by tawanda mushiri and charles mbohwa.
- [6]. "an overview on 3d printing technology: technological, materials printing and application. n. shahrubudina, t.c. lee, r. ramlan. 2351-9789 © 2019 the authors. published by Elsevier b.v.peer-review under responsibility of the organizing committee of smpm 2019.
- [7]. "comparison of mechanical behavior of metallic and composite front door of a standard automobile car by fea" by aniket chandu thosar the university of texas at arlington spring 2017
- [8]. "3d printing technologies and composite materials for structural applications." by rajkumar velu, felix raspall, saratsingamneni.
- [9]. "additive manufacturing of honeycomb structure and analysis of infill and material characteristics." by b.vishnuvardhana naidu , g. dileep kumar
- [10]. "an experimental and numerical investigation of a novel 3d printed sandwich material for motorsport application." by danial harland, ahmed w. alshaer, hardley brooks.
- [11]. <https://www.britannica.com/science/organic-compound>
- [12]. <https://byjus.com/chemistry/polyethylene/>
- [13]. <https://omnexus.specialchem.com/selection-guide/acrylonitrile-butadiene-styrene-abs-plastic>

IJEAST

INTERNATIONAL JOURNAL
OF ENGINEERING APPLIED SCIENCE
AND TECHNOLOGY

ABOUT IJEAST

International Journal of Engineering Applied Science and Technology (IJEAST) is a peer-reviewed, open access journal that publishes high-quality research papers in the field of Engineering, Applied Science and Technology.

IJEAST aims to provide a platform for researchers, academicians, and professionals to share their innovative ideas, research findings, and practical experiences with the global scientific community.

FOCUS AREAS

- Engineering
- Applied Science
- Technology
- Innovation & Development
- Interdisciplinary Studies



PEER REVIEWED

All submissions are rigorously peer reviewed to ensure quality.



OPEN ACCESS

Free and unrestricted access to research for all.



GLOBAL REACH

Connecting researchers and professionals worldwide.



TIMELY PUBLICATION

We ensure a swift and efficient publication process.



For more information, visit our website

www.ijeast.com



INTERNATIONAL JOURNAL
OF ENGINEERING APPLIED SCIENCE
AND TECHNOLOGY

✉ editor@ijeast.com

🌐 www.ijeast.com

📍 India



2455-2143