



IJEAST

INTERNATIONAL JOURNAL
OF ENGINEERING APPLIED SCIENCE
AND TECHNOLOGY



VOLUME : 7 ISSUE : 06 Print / Issue Publication Date: 24-Dec-2022



ISSN : 2455-2143



DOI : 10.33564/IJEAST.2022.v07i06.014

Indexed In



WWW.IJEAST.COM

editor@ijeast.com



COMPENSATION OF HARMONICS TO IMPROVE POWER QUALITY USING HYBRID ACTIVE POWER FILTER

Yogananda.B.s
Assistant professor,
Department of EEE,
SSIT, Tumkur

Dr. K. Thippeswamy
Selection Grade Lecturer,
S.J Govt.Polytechnic, Bangalore

Abstract: This paper presents design, simulation and development of hybrid active power filter for mitigation of the power quality problem at ac mains in ac-dc power supply feeding to a nonlinear load. The power filter is consisting of a shunt passive filter connected in series with an active power filter. At first passive filter has been designed to compensate harmonics. The drawback associated with the passive filter like fixed compensation characteristics and resonance problem is tried to solve by HAPF. Simulations for a typical distribution system with a hybrid power filter have been carried out to validate the presented analysis. Harmonic contents of the source current has been calculated and compared for the different cases to demonstrate the influence of harmonic extraction circuit on the harmonic compensation characteristic of the shunt hybrid power filter.

Key Words: Hybrid Active Filter, p-q Theorem, Total Harmonic Distortion.

I. INTRODUCTION

Harmonics increase in the supply [1]. As discussed above both active filters and passive filters suffer from a number of disadvantages. Therefore, another solution of harmonic mitigation, called HAPF (Hybrid Active Power Filter), has been introduced. HAPF provides the combined advantages of APF and PPF and eliminate their disadvantages. These topologies are cost effective solutions of the high-power LC and high reliability is the main advantage of passive filters [2]. However, passive filters suffer from some shortcomings for example, the performance of these filters is affected due to the varying impedance of the system and with the utility system the series and parallel resonances may be created, which cause current harmonics increase in the supply [3].

As discussed above both active filters and passive filters suffer from a number of disadvantages. Therefore, another solution of harmonic mitigation, called HAPF (Hybrid Active Power Filter), has been introduced. HAPF provides the combined advantages of APF and PPF and eliminate their disadvantages. These topologies are cost effective solutions of the high-power power quality problems with well filtering performance. This research paper is restricted to the (HAPF). The (HAPF) is specially designed to compensate the reactive power and decrease the harmonic currents occurred on the side of load from the grid, by injecting the current having same magnitude but opposite in the phase direction of the harmonic current [4].

In the literature a number of methods has been emphasized for identification of reference current [5-9]. For identification of disturbing current the instantaneous reactive power method has been used in this paper. For controlling the output currents of the converter, to follow the reference currents, hysteresis current controller has been used in [10]. The implementation of hysteresis current controller is simple and its performance is good. Therefore hysteresis control technique has been used for generating the switching pulses for voltage source converter.

II. COMPENSATION PRINCIPLE OF SHUNT PASSIVE FILTER

A passive shunt filter consists of several LCR branches each tuned at particular frequency. Fig.1 shows the equivalent circuit diagram of a passive shunt filter. The compensation principle of LC passive shunt filter is as follows:

$$\frac{I_s}{V_1} = \frac{Z_{sh}}{Z_1 Z_s + Z_1 Z_{sh} + Z_s Z_{sh}} \quad (1)$$

Where, Z_{sh} is the impedance of the parallel LC filter. From (1) it can be seen that the performance of parallel LC filter



depends on the source impedance and is determined only by the ratio of the source impedance and the filter impedance. If $Z_1 = 0$, then $I_s = I_1$, which means that the passive filter is not effective. But if $Z_s = 0$, then

$$\frac{I_s}{V_1} = \frac{1}{Z_1}$$

which means that the filter does not provide harmonic compensation.

It is seen that the filter interaction with the source impedance results in a parallel resonance. For inductive source impedance (Z_s), this occurs at a frequency below the frequency at which the filter is tuned. It is as follows:

$$f_{\text{sys}} = \frac{1}{2\pi(L_s + L)c} \quad (2)$$

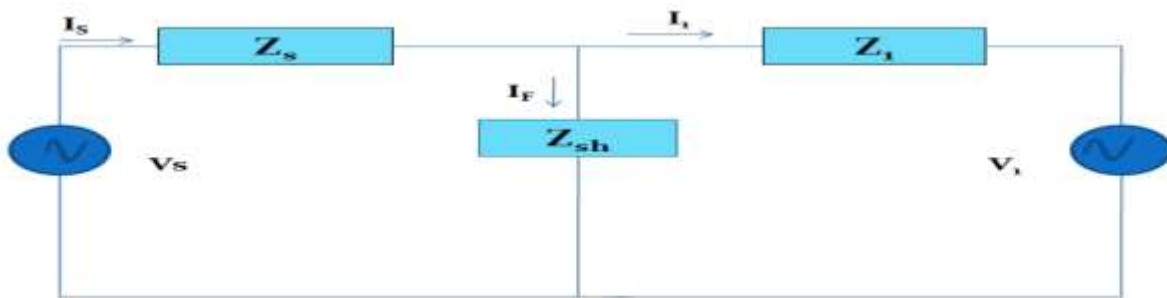

Fig.1 Equivalent circuit diagram of passive shunt filter based configuration

III. DESIGN OF SHUNT PASSIVE FILTER

The passive shunt filter consists of first order series tuned low pass filters tuned for 5th and 7th harmonics and a second order damped high pass filter tuned for 11th harmonics.

Low pass filter:

For the series tuned low pass filter the impedance is:

$$Z_{\text{sh}}(h) = \left[R + j \left(hX_L - \frac{X_C}{h} \right) \right] \quad (3)$$

$$X_C = \frac{V_{ph}^2}{Q_{sh} h} \quad (4)$$

$$X_L = \frac{X_C}{h^2} \quad (5)$$

Where Q_{sh} = reactive power provided by the passive filter in VAR per phase, X_L = reactance of inductor, X_C =

If the filter is tuned exactly at a concern frequency then an upward shift in the tuned frequency results in a sharp increase in impedance as seen by the harmonic. There are some common mechanisms which may cause filter detuning. They are as follows:

Capacitor fuse-blowing, which lowers the total capacitance, thereby raising the frequency at the filter has been tuned.

Temperature variation.

System parameter variation.

Manufacturing tolerances in both inductor as well as capacitor.

So the filter banks are tuned to around 6% below the desired frequency as per IEEE standard 1531.

reactance of capacitor, h = harmonic order of the passive filter, V_{ph} = Phase voltage Initially the reactive power requirement is assumed to be 25% of the rating of the load. It may be equally divided into different filter branches. The value of series tuned element can be calculated from (4) and (5).

The quality factor of the low pass filter is:

$$QF = \frac{X_L}{R} \quad (6)$$

Here the quality factor is assumed to 30 to calculate the value of the resistive element. The resonant frequency is given by

$$f_0 = \frac{1}{2\pi\sqrt{LC}} \quad (7)$$

Where, R = filter resistance

L = filter inductance

C = filter capacitance

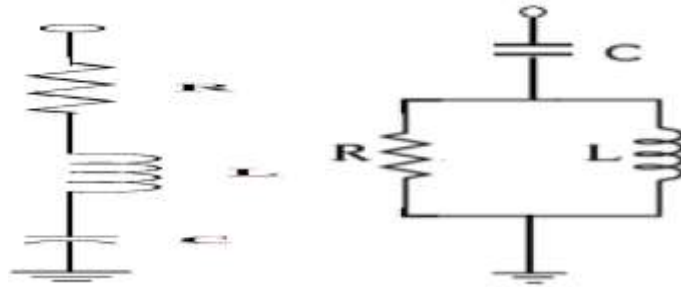

Fig.2 Low pass filter. Fig.3 High pass filter.

High pass filter:

For second order damped filter, the impedance at any harmonics h becomes:

$$Z_{sh} = \left[\frac{R(hX_L)^2}{R^2 + (hX_L)^2} + j \left(\frac{R^2 hX_L}{R^2 + (hX_L)^2} - \frac{X_C}{h} \right) \right] \quad (8)$$

$$X_C = \left(\frac{h_n^2}{h_n^2 - 1} - \frac{V^2}{Q_{sh} h} \right) \quad (9)$$

Resonant frequency for h^{th} harmonic is

$$f_0 = \frac{1}{2\pi hCR} \quad (10)$$

Quality factor can be expressed as

$$QF = \frac{L}{R^2 C} \quad (11)$$

The design of passive shunt filter is carried out as per the reactive power requirements. The filter is designed to compensate the reactive power of the system. Hence the passive filter helps in maintaining the regulation of dc link voltage within limits and power factor improvement as improving the THD of supply current. It also sinks the harmonic currents of the frequencies at which the passive filter has been tuned.

Depending on the harmonic spectrum of the supply current passive filter is designed for low pass filters which is tuned for 5th and 7th harmonic frequency and high pass filter which is tuned for 11th harmonic frequency shown in Fig.2 In low pass filter R , L , and C are connected in series. The high pass filter Fig.3 consists of a capacitor which is connected in series with the parallel combination of the resistor and inductor to the converter.

In this project work passive LC filter is designed for the 5th and 7th order harmonic frequency, and the filter component values are:

Table 1: Passive Filter components

Harmonics	Capacitor(F)	Inductor(H)
5 th	$C_5=11.24e-3$	$L_5=0.9e-3$
7 th	$=15.7e-3 C_7$	$L_7=0.64e-3$

IV. MODELLING OF THE SHPF

Model in a-b-c reference frame:

Kirchhoff's law of voltage and currents applied to this system provide three differential equations in the stationary "a-b-c" frame (for $k = 1, 2, 3$).

$$V_{sk} = L_{PF} + R_{PF} i_{ck} + \frac{1}{C_{PF}} \int i_{ck} dt + v_{kM} + v_{MN} \quad (12)$$

Differentiating (11) we get



$$\frac{dv_{sk}}{dt} = L_{PF} \frac{d^2 i_{ck}}{dt^2} + R_{PF} \frac{di_{ck}}{dt} + \frac{1}{C_{PF}} i_{ck} + \frac{dv_{kM}}{dt} + \frac{dv_{MN}}{dt}$$

Assume that the zero sequence current is absent in a three phase system and the source voltages are balanced, so we obtain:

$$v_{MN} = -\frac{1}{3} \sum_{k=1}^3 v_{kM} \quad (13)$$

We can define the switching function C_k of the converter k^{th} leg as being the binary state of the two switches S_k and S'_k . Hence, the switching C_k (for $k = 1, 2, 3$) is defined as $C_k = 1$, if S_k is On and S'_k is Off, $C_k = 0$, if S_k is Off and S'_k is On.

$$(14)$$

Thus, with $V_{kM} = C_k V_{dc}$, and from (4.4), the following relation is obtained:

$$\frac{d^2 i_{ck}}{dt^2} = -\frac{R_{PF}}{L_{PF}} \frac{di_{ck}}{dt} - \frac{1}{C_{PF} L_{PF}} i_{ck} - \frac{1}{L_{PF}} \left(C_k - \frac{1}{3} \sum_{m=1}^3 C_m \right) \frac{dv_{dc}}{dt} + \frac{1}{L_{PF}} \frac{dv_{sk}}{dt}$$

$$(15)$$

Let the switching state function be defined as

$$q_{nk} = \left(C_k - \frac{1}{3} \sum_{m=1}^3 C_m \right)_n \quad (16)$$

The value of q_{nk} depends on the switching state n and on the phase k . This shows the interaction between the three phases. Conversion from $[C_k]$ to $[q_{nk}]$ is as follows

$$q_{n1} = \frac{2}{3} C_1 - \frac{1}{3} C_2 - \frac{1}{3} C_3 \quad (17)$$

$$q_{n2} = -\frac{1}{3} C_1 - \frac{1}{3} C_2 + \frac{2}{3} C_3 \quad (18)$$

$$q_{n3} = -\frac{1}{3} C_1 + \frac{1}{3} C_2 + \frac{2}{3} C_3 \quad (19)$$

Hence we got the relation as

$$\begin{bmatrix} q_{n1} \\ q_{n2} \\ q_{n3} \end{bmatrix} = \frac{1}{3} \begin{bmatrix} 2 & -1 & -1 \\ -1 & 2 & -1 \\ -1 & -1 & 2 \end{bmatrix} \begin{bmatrix} C_1 \\ C_2 \\ C_3 \end{bmatrix} \quad (20)$$

The matrix in (20) is of rank 2 q_{nk} has no zero sequence components. By the analysis of the dc component of the system it gives

$$dv_{dc} = \frac{1}{C_{dc}} i_{dc} = \frac{1}{C_{dc}} \sum_{k=1}^3 q_{nk} i_{nk} \quad (21)$$

With the absence of zero sequence components in i_k and q_{nk} one can get

$$\frac{dv_{dc}}{dt} = \frac{1}{C_{dc}} (2q_{n1} + q_{n2}) i_{c1} + \frac{1}{C_{dc}} (q_{n1} + 2q_{n2}) i_{c2} \quad (22)$$

Hence the complete model of the active filter in “a-b-c” reference frame is obtained as follows.

$$L_{PF} \frac{d^2 i_{c1}}{dt^2} = -R_{PF} \frac{di_{c1}}{dt} - \frac{1}{C_{PF}} i_{c1} - q_{n1} \frac{dv_{dc}}{dt} + \frac{dv_{s1}}{dt}$$

$$L_{PF} \frac{d^2 i_{c2}}{dt^2} = -R_{PF} \frac{di_{c2}}{dt} - \frac{1}{C_{PF}} i_{c2} - q_{n2} \frac{dv_{dc}}{dt} + \frac{dv_{s2}}{dt}$$

$$C_{dc} \frac{dv_{dc}}{dt} = (2q_{n1} + q_{n2}) i_{c1} + (q_{n1} + 2q_{n2}) i_{c2} \quad (23)$$

The above model is time varying and nonlinear in nature.

V. SOFTWARE IMPLEMENTATION

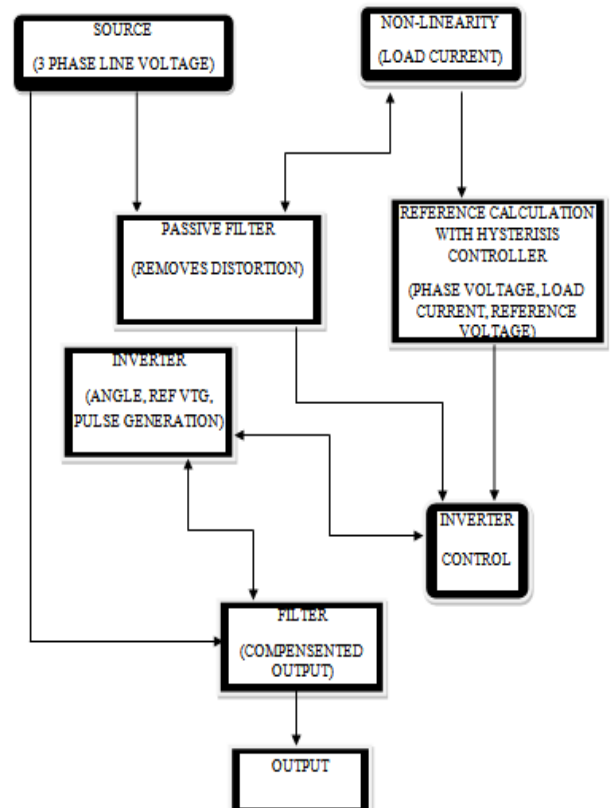

Fig 4a Flow diagram of the process

SIMULATION CIRCUIT PARAMETER

The values of the circuit parameter are an important factor for the simulation. And the parameter values are tabulated as:

Table 2: Simulation parameters

Supply Voltage	V _s =220Vrms
Supply/Line Inductance	L _s = 0.0016 Henry
Rectifier Front-End Inductance	L _L = 0.023 Henry
Capacitance of the Load	C _L = 50 Micro Farad
Resistance of the Load	R _L =78 Ohm
Capacitance of Inverter dc-Bus	C _{dc} = 4500 Micro Farad

The values which we need to design the filter elements of the Hybrid power filter elements are tabulated as:

Table 3: Values of designed filter

C (F)	L (H)	R (Ω)
C _{HP} = 3.25e-6	L _{HP} = 0.025	R _{HP} = 260

The shunt hybrid power filter which is connected to a voltage source type non-linear load is simulated by using MATLAB SIMULINK environment. The scheme is first simulated without any filter to find out the THD of the supply current. Then it is simulated with the hybrid filter to observe the difference in THD of supply current. Simulation is also carried out with hysteresis controller and P-I controller to find out the comparative study of the THD of the supply current.

Total Harmonic Distortion of a signal is a measurement of the harmonic distortion present and is defined as the ratio of the sum of the powers of all harmonic components to the power of the fundamental frequency.

When the input is a pure sine wave, the measurement is most commonly the ratio of the sum of the power of all higher harmonic frequencies to the power at the first harmonic, or fundamental frequency.

$$THD = \frac{P_2 + P_3 + P_4 + \dots + P_\infty}{P_1} = \frac{\sum_{i=2}^{\infty} P_i}{P_1}$$

This can equivalently be written as

$$THD = \frac{P_{total} - P_1}{P_1}$$

If there is no source of power other than the signal and its harmonics.

Measurements based on amplitudes (e.g. voltage or current) must be converted to powers to make addition of harmonics

distortion meaningful. For a voltage signal, for example, the ratio of the squares of the RMS voltages is equivalent to the power ratio:

$$THD = \frac{V_2^2 + V_3^2 + V_4^2 + \dots + V_\infty^2}{V_1^2}$$

Where V_i is the RMS voltage of ith harmonic and i = 1 is the fundamental frequency.

THD is also commonly defined as an amplitude ratio rather than a power ratio, resulting in a definition of THD which is the square root of that given above:

$$THD = \frac{\sqrt{(V_2^2 + V_3^2 + V_4^2 + \dots + V_\infty^2)}}{V_1}$$

Implementation of Design of Three-Phase Hybrid Active Power Filter for Compensating the Harmonic Currents of Three-Phase System IN MATLAB/SIMULINK

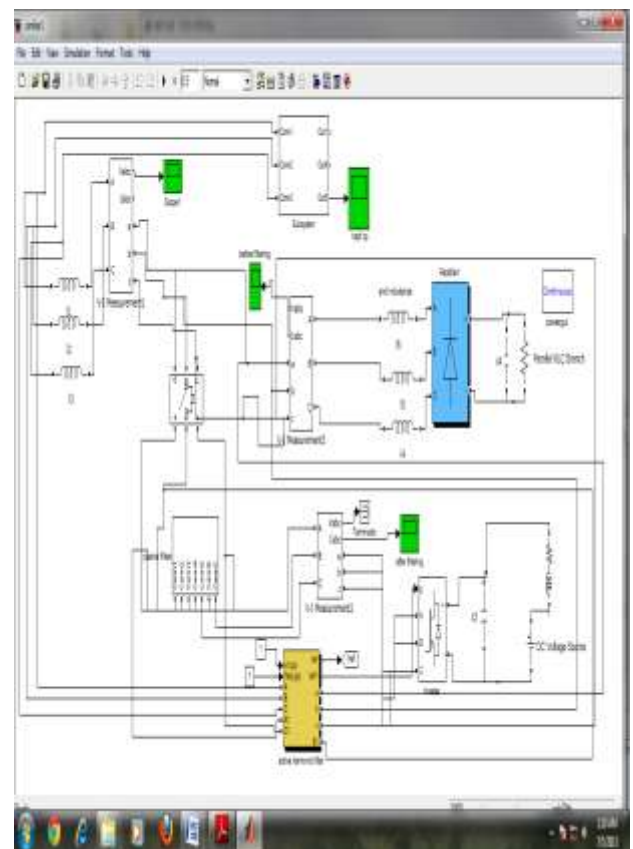

Fig 4b. MATLAB SIMULINK model of Design of Three-Phase Hybrid Active Power Filter for Compensating the Harmonic Currents of Three-Phase System

SIMULATION RESPONSE OF NON LINEAR LOADS
Simulation response without filter

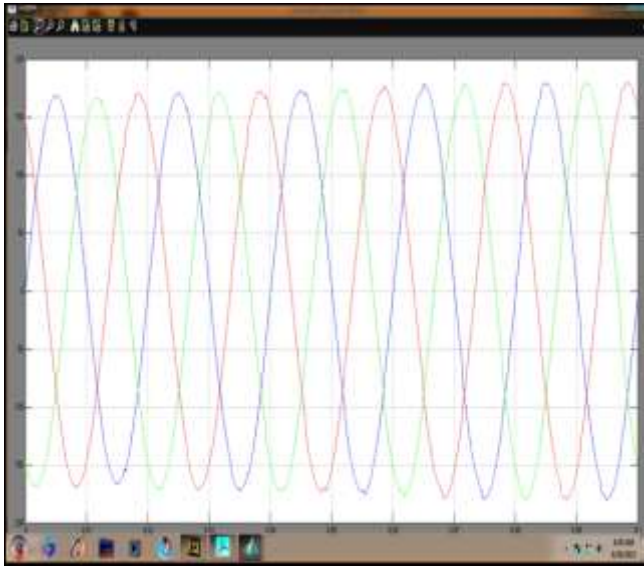

Fig.5 Wave forms of Supply Voltage (V) without filter
 Fig.5 shows the three phase supply voltage waveform before filtering, and it is supplied to the circuit. This creates a distortion in the line.

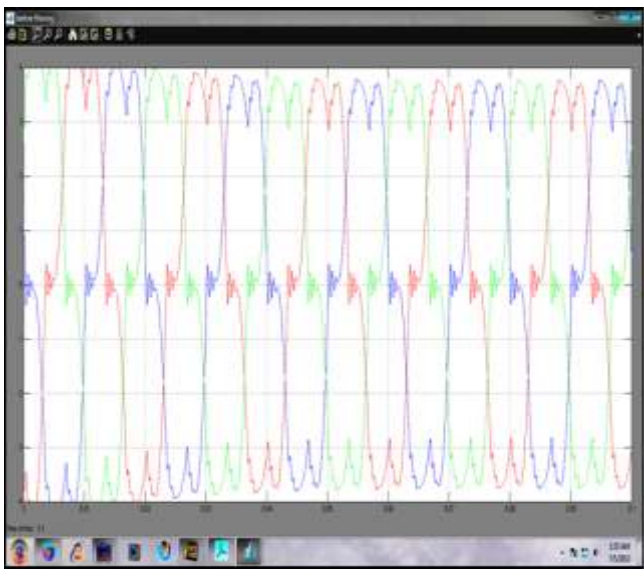

Fig. 6 Wave forms of Supply Current (A) without filter

Fig.6 shows the supply current without filter. We Can see that the current is not in phase with the voltage.

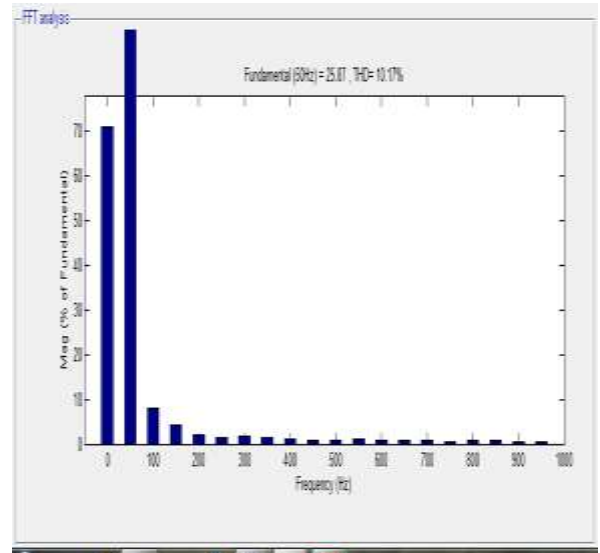

Fig. 7 THD (%) of the supply Current before Filtering

Total Harmonic Distortion of the supply current is calculated in the FFT analysis in the MATLAB software and the supply current before filtering is given as 10.17% which is abnormal THD under IEEE standards.

Simulation response with hybrid filter

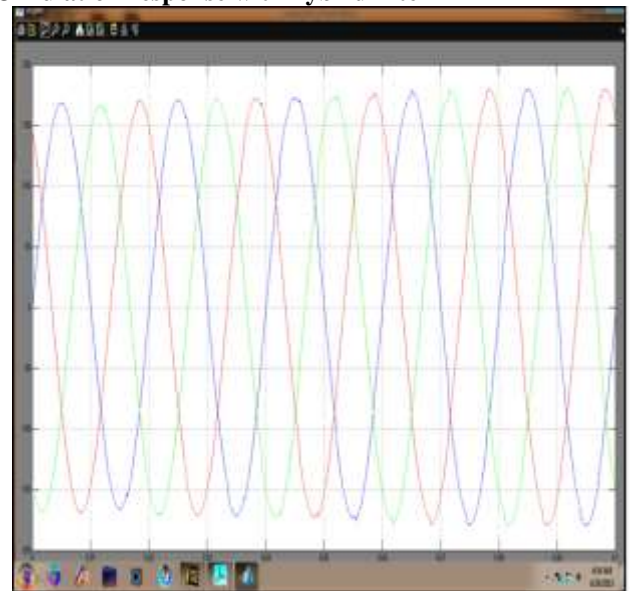

Fig.8 Wave forms of Supply Voltage (V) with hybrid filter.

The Fig.8 shown is the waveform of the Supply voltage with Hybrid filter. This is the supply voltage to supplied to the control block and have less distortion because of filtering through the hybrid filter.

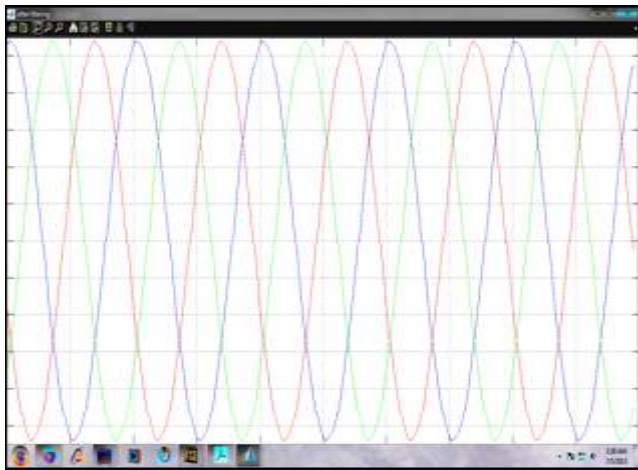

Fig. 9 Supply currents waveforms after filtering

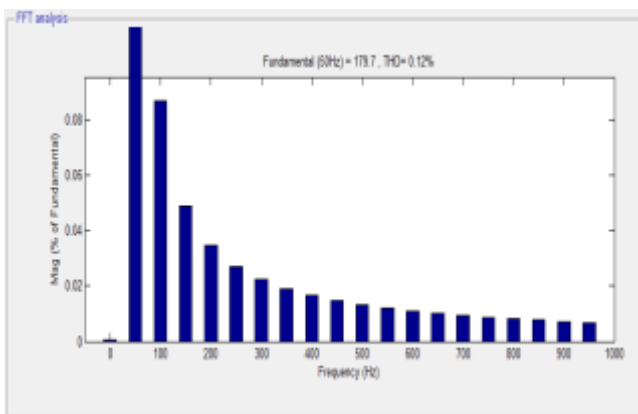

Fig. 10 THD (%) of the supply Current After Filtering

Fig.9 and 10 shows the supply current waveform after filtering through the hybrid filter and its corresponding THD level using FFT analysis. This will gives THD of 0.12% which is in under IEEE 519 power quality condition.

HYBRID FILTER CURRENT:

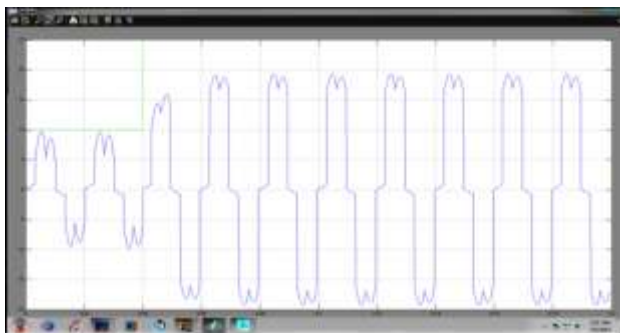

Fig. 11 Hybrid Active filter output current and reference current

Fig. 11 shows the Hybrid filter current with the harmonic distortion of 29%. And this current is used as reverse harmonic and transfer this current in the opposite direction. So this current makes with difference in the line with the supply harmonics and eliminates the harmonics in the supply current.

The comparison between supply current harmonics with and without filter is tabulated in the below table. This gives the brief description of the supply current variation with filter.

Table 4: Comparison with and without filter

Currents	THD (%) before Compensation	THD (%) after compensation
	Without filter	With hybrid Filter
Supply current	10.17	0.12
Filter current	Nil	29.59

VI. CONCLUSION

The quality of the waveform is based on the value of total harmonic distortion. Therefore, THD factor of the source current is analyzed in time and frequency domains. From the results it is evident that the HPF effectively reduces the THD produced by nonlinear load. The main objective of this research work has been accomplished. The total distortion of the supply current has been decreased at a high level of expectation from 10.17% to 0.12% in the simulation, which is an achievement to meet the IEEE 519 recommended harmonic standard.

This work presents design of shunt passive filter and shunt hybrid power filter for a distribution system. The hybrid filter reduces the harmonics as compare to open loop response. This hybrid filter is tested and verified using MATLAB program. A P-I controller and hysteresis controller is implemented for three phase shunt hybrid power filter. The P-I controller and hysteresis controller extracts the reference current from the distorted line current and hence improve the power quality parameters such as harmonic current and reactive power due to nonlinear load. Current source type of non-linear load is implemented. The harmonic current control and DC capacitor voltage can be regulated under these non-linear loads. We obtained it from the simulation responses. The shunt hybrid power filter is verified with the simulation results. Hence we obtained a comparative result by using this two controllers.



VII. REFERENCE

- [1]. H.Akagi (1998), "New trends in active filters for power conditioning", IEEE Trans. Ind.Application., vol.32,n0.6,pp.1312-1320.
- [2]. H.Akagi (2002), "A medium voltage transformer less AC/DC power conversion system consisting of a diode rectifier and a shunt hybrid filter", IAS Annual meeting, vol.1,pp78-85.
- [3]. P. Correa, J. Rodriguez, I. Lizama, and D. Andler,(2009), ". "A predictive control scheme for current-source rectifiers", IEEE Trans. Ind. Electron., vol. 56, no. 5, pp. 1813–1815.29.
- [4]. N. Prabhakar and M. Mishra,(2010), "Dynamic hysteresis current control to minimize switching for three-phase four-leg VSI topology to compensate nonlinear load," IEEE Trans. Power Electron., vol. 25, no. 8, pp. 1935–1942.
- [5]. Pichai Jintakosonwit,(2003), "Implementation and performance of cooperative control of shunt active filters for harmonic damping throughout a power distribution system", IEEE transactions on industry applications, vol. 39, no. 2.
- [6]. Wu, T.F., Shen, C.L., Chang, C.H., and Chiu, J.Y.,(2003), "A 1- Φ 3W Grid-Connection PV Power Inverter with Partial Active Power Filter", IEEE Transaction on Aerospace and Electronic Systems, Volume 39, No. 2, pp. 635-646.
- [7]. Mohseni, M., and Islam, S.M., (2010) "A New Vector-Based Hysteresis Current Control Scheme for Three-Phase PWM Voltage-Source Inverters", IEEE Transactions on Power Electronics, Volume 5, No. 9, pp. 2299-2309.
- [8]. Zhou, T., and Francois, B.(2011.), "Energy Management and Power Control of a Hybrid Active Wind Generator for Distributed Power Generation and Grid Integration", IEEE Transactions on Industrial Electronics, Volume 58, No. 1.
- [9]. S. Khalid & Bharti dwivedi,(2011) "Power Quality issues, standards, problems and their effects in industry with corrective mean", IET Lucknow , ISSN:2231-1963.
- [10]. Tahmid,Rashik and Shameem Ahmad (2017), "power quality improvement by using shunt hybrid active power filter",Electrical, Computer and Communication Engineering international conference,IEEE.
- [11]. Das,Soumya Ranjan,Prakash K Ray and Asit Mohanty.(2017) "Improvement in power quality using hybrid power filters based on RLS algorithms", Energy Procedia 138: 723-728.
- [12]. B.S Yogananda and Dr. K Thippeswamy (2018), "Design of power filters to improve power quality in power systems", IEEE XPLORE.
- [13]. B.S Yogananda and Dr. K Thippeswamy (2022), "Improvement of power quality in wind energy conversion systems", International journal for research in applied science and engineering technology,ISSN:2321-9653, Vo. 10,pp. 12-20.
- [14]. B.S Yogananda et.al(2021), "Power quality analysis in grid connected wind energy conversion system", International journal of engineering and technology, Vo. 10,pp. 136-139.
- [15]. B.S Yogananda and Dr. K Thippeswamy (2014), "Analysis and Simulation of a Shunt Active Filter to Solve Harmonics Problems", global journal of advanced engineering technologies, Vo. 03,pp. 22 - 26.

IJEAST

INTERNATIONAL JOURNAL
OF ENGINEERING APPLIED SCIENCE
AND TECHNOLOGY

ABOUT IJEAST

International Journal of Engineering Applied Science and Technology (IJEAST) is a peer-reviewed, open access journal that publishes high-quality research papers in the field of Engineering, Applied Science and Technology.

IJEAST aims to provide a platform for researchers, academicians, and professionals to share their innovative ideas, research findings, and practical experiences with the global scientific community.

FOCUS AREAS

- Engineering
- Applied Science
- Technology
- Innovation & Development
- Interdisciplinary Studies



PEER REVIEWED

All submissions are rigorously peer reviewed to ensure quality.



OPEN ACCESS

Free and unrestricted access to research for all.



GLOBAL REACH

Connecting researchers and professionals worldwide.



TIMELY PUBLICATION

We ensure a swift and efficient publication process.



For more information, visit our website
www.ijeast.com



INTERNATIONAL JOURNAL
OF ENGINEERING APPLIED SCIENCE
AND TECHNOLOGY

✉ editor@ijeast.com

🌐 www.ijeast.com

📍 India



2455-2143